

Article number: 03504040

Description: Fluro Rod end GE 40LO

Measures

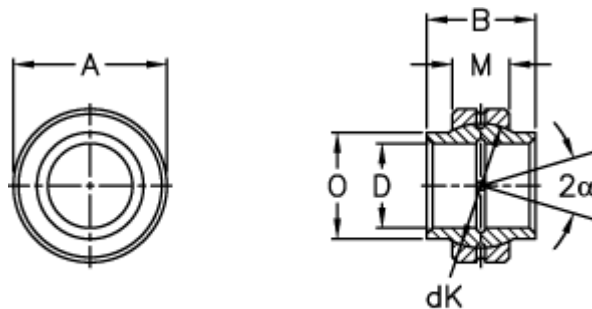

Str. 12 den smørerille

A	= 62 0 -0,013	Tilt angle = 4
B	= 40	Weight = 330
D	= 40 0 +0,025	
dK	= 53	
Dynamic load C (kN)	= 100	
M	= 22	
O	= 46	
Static load C0 (kN)	= 500	